

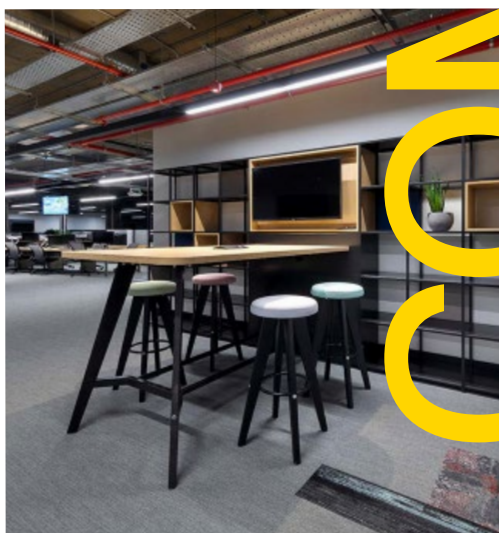

Quick Overview ZD+

April 2025



WELCOME TO OUR WORLD

Staverton has a longstanding history in office furniture design. We are recognised for bringing form, function and flexibility together without compromise. By involving our clients at every stage of the work process, we find –together– the right solution for their specific needs.

British and proud, we have a manufacturing facility in South Yorkshire and a showroom in Clerkenwell, London. With the latest BAZ processing machinery recently installed, the factory has more than 38,000 sq ft of space for manufacture and assembly and ample room for our design team to turn client requirements into fully developed designs.

Staverton's skilled team of professionals is committed to delivering the highest quality requirements: our products are designed to achieve FIRA's gold standard, the world's leading independent furniture testing centre. Our bespoke approach, innovative design and collaborative method have earned us a name as a responsible and reliable award-winning British manufacturer.

We comply with all industry regulations, including the supply of responsibly sourced wood, on-site personnel safety and conduct, quality control, and adherence to management standards such as ISO 9001, ISO 14001, BSI Membership, Safe Contractor Certificate, FIRA Gold Certificate, FISP Membership and FSC Certificate.



012



The mark of responsible forestry





POSITIVE CHANGE

We need to be the change we want to see. Leading by example while learning from others is the best way to drive change.

Business as usual is no longer enough. Nor is merely complying with regulations. We must do more than is expected of us. We need to improve each day. We need to understand our whole impact on the world. And we need to work together to ensure that we learn from each other and drive change.

There is an onus on us not just as manufacturers and designers of products but as individuals. Sustainability can be designed into systems and products, but the real change we need to see is in our attitudes and behaviours. We are all in this together and we all have a role to play.

[Join Us](#)

Respect for the environment is in Staverton's DNA. We care for our setting by creating sustainable, environmentally friendly products.

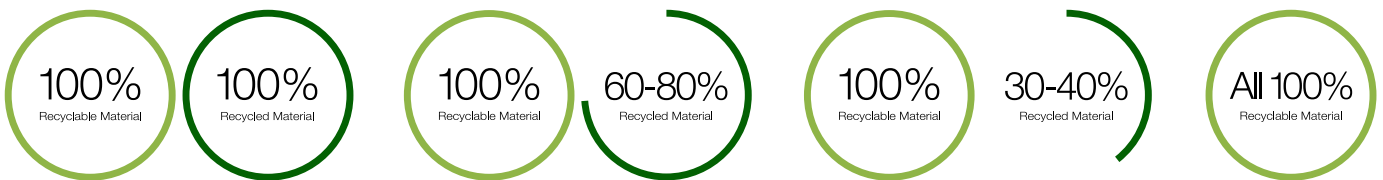

Frame, Legs and Brackets
(Mild Steel)

FSC Certified Worksurfaces
(MFC Wood)

Actuators and Control
(Height Adjustable Actuators Column Motor Drive)

Edging
(ABS)

Screen Trim
(Virgin PVC Anchor)

Screen Upholstery Fabric
(Polyester)

Packaging
(Cardboard)

Electrics
(Powerbar, Power Unit Interconnector Lead)

Minimalist Aesthetic Maximum Practicality

ZD+

A full collection of desks, benches and tables feature light floating tops that sit away from the structural frame to provide a clean, sharp and modern look.

Quality is assured thanks to a lifetime framework guarantee. Plus the ZD+ range is FIRA Gold certified – the ultimate mark of furniture quality and excellence.

Individual workstation heights can be block-adjusted by up to 100mm for added functionality. ZD+'s screens can also be personalised by choosing from a diverse range of fabric alternatives, textures and colours.

Bench leg frame sizes are available in 1600mm or 1200mm depths and desk leg frame sizes are available in 800mm or 600mm depths. The framework is designed to accommodate a variety of sizes and shaped top panels. For additional details, please contact the Staverton team.



ZD+ offers unprecedented flexibility for today's changing office environment. It's easy to install, easy to specify, and easy to reconfigure.



Desktop power and data distribution options are available.



There are several standard fabric ranges available for screens, with each range providing a broad selection of colours to choose from.

Extended Options

The ZD+ range offers many options including inset end-legs, soft barrel-shaped worktops and retrofittable sit-stand conversion kits to meet your workplace needs.



Future-Proofed Telescopic Beam

ZD+'s telescopic cable managed beams enable the size of the workstation to change over time and extend the life of the product. The beam also has integral horizontal cable management capability.



Discreet Cable Management

Cable management is simple and effective, concealing all vertical and horizontal cable paths discreetly. A vertical cable management riser hides cables from view, and a large-capacity hook-on cable management tray can be hinged down from either side.

Typical Bench Configuration



Four-Person Back-To-Back Bench

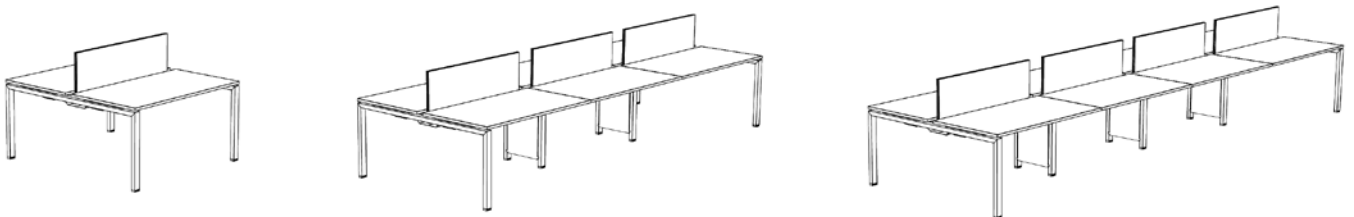

Typical back-to-back bench configurations, two-person, six-person and eighth-person.

Typical Desk Configuration

ZD+



Single-Person Desk

Bench Assembly

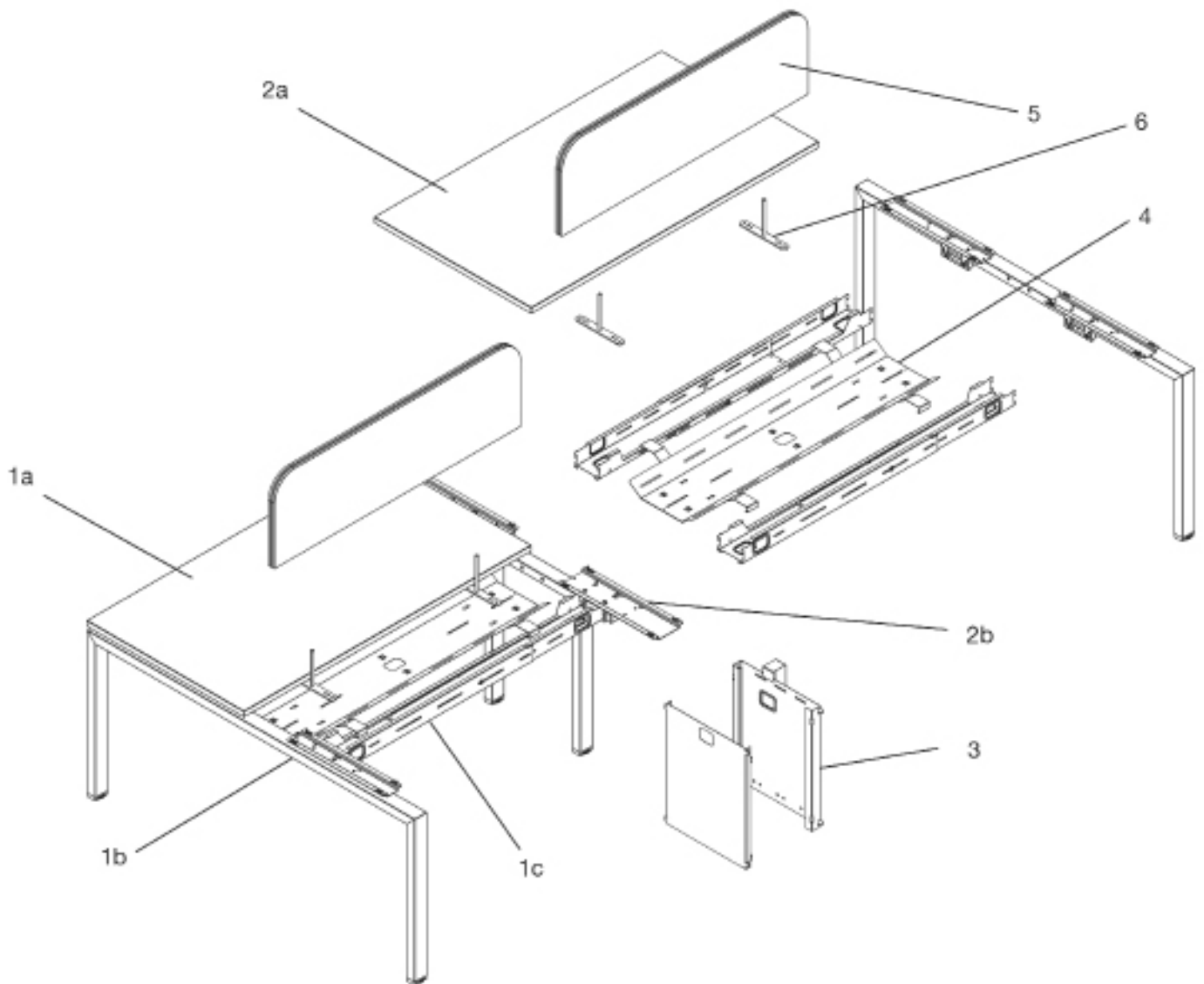

1) Bench Module

Consisting of:

1a) Standard Bench Worksurface

1b) Bench End Leg Frame

1c) Telescopic Bench Beam

2) Bench Extension

Consisting of:

2a) Standard Bench Worksurface

2b) Bench Shared Leg Frame

2c) Telescopic Bench Beam

Accessories to Be Ordered Separately

3) 1x Mass Cable Riser

4) Bench Wire Management Tray

5) Bench Screen Fabric with Central Trim and 2x Rounded Top Corners

6) Bench Screen Fixing Bracket

Desk Assembly

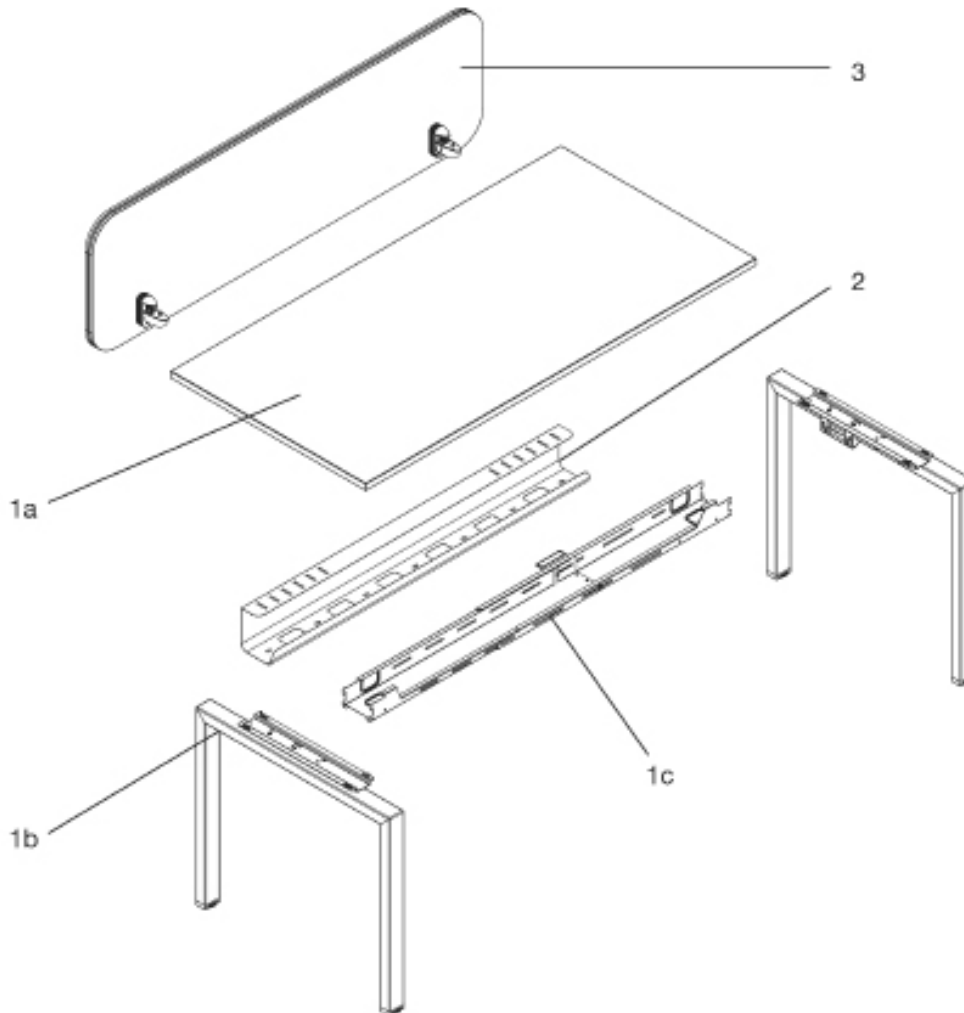

1) Desk Module

Consisting of:

1a) Standard Desk Worksurface

1b) Desk End Leg Frame

1c) Telescopic Desk Beam

Accessories to Be Ordered Separately

2) 1x Desk Worksurface Mounted Wire Management Tray

3) Desk Screen Fabric with Central Trim and 4x Rounded Corners

Fabric Band Information

Fabric Band B



Camira Lucia

Fabric Band C



Camira Blazer Lite

Fabric Band E



Camira Blazer



Camira Synergy

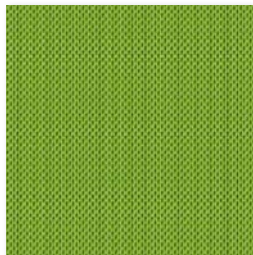

Camira Nexus

Notes

All fabrics are foam backed with 2mm or 3mm foam backing (as appropriate) to achieve the best possible finish and feel.

Finishes

Standard Worksurfaces and ABS Edge Finishes (25mm Thick Melamine)

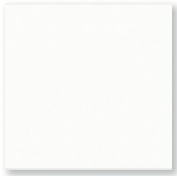

Traffic White
W1000

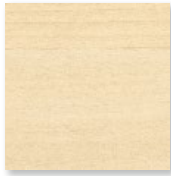

Sand Birch
H1732



Oak
D1929

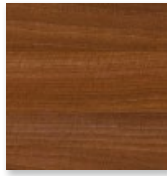

Walnut
H3704

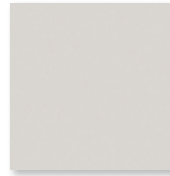

Light Grey
U708



Dust Grey
U732



Anthracite
U164

Contrast Edging



Black
U999

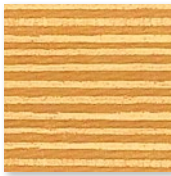

2D Ply
'S'

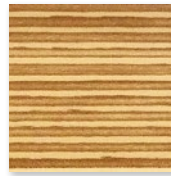

3D Ply¹
'M'

Frame



Satin White
'K'



Satin Black
'P'



Silver
'V'

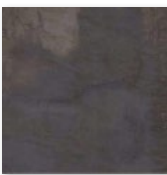

Clear Coat Over
Raw Steel
'S'

Notes

Please note that due to the manufacturing process, some finish consistencies may occur. Every component is unique. Please note that due to the organic nature of the Oak, some finish inconsistencies may occur.

¹ Premium Edge Finish - 3D Ply 'M'

Bench Elevation

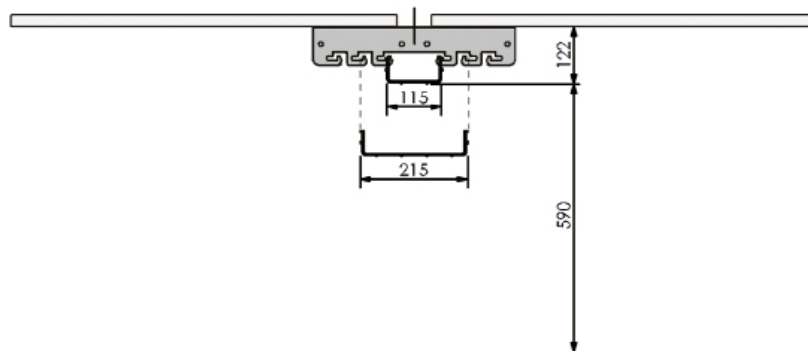
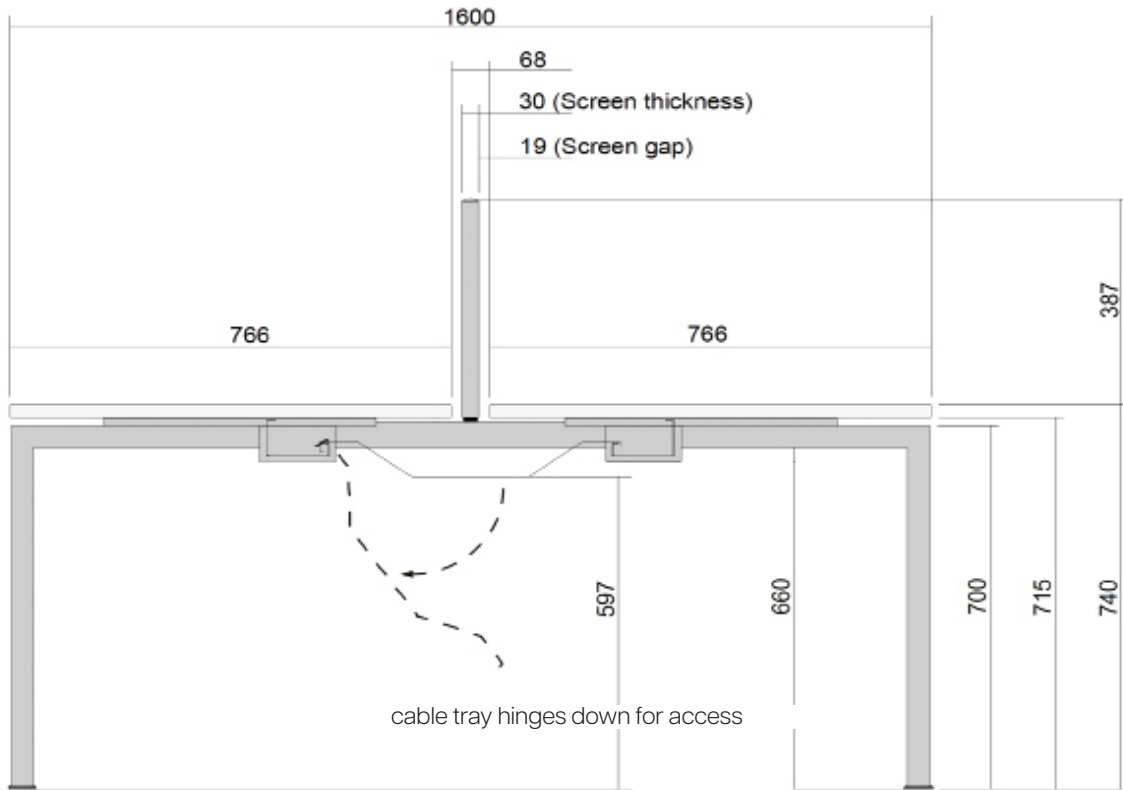

The Bench Cable Basket sits centrally between the two worksurfaces.
 Bench Cable Baskets can be either 115mm or 215mm wide, depending on the brackets used.

Desk Elevation

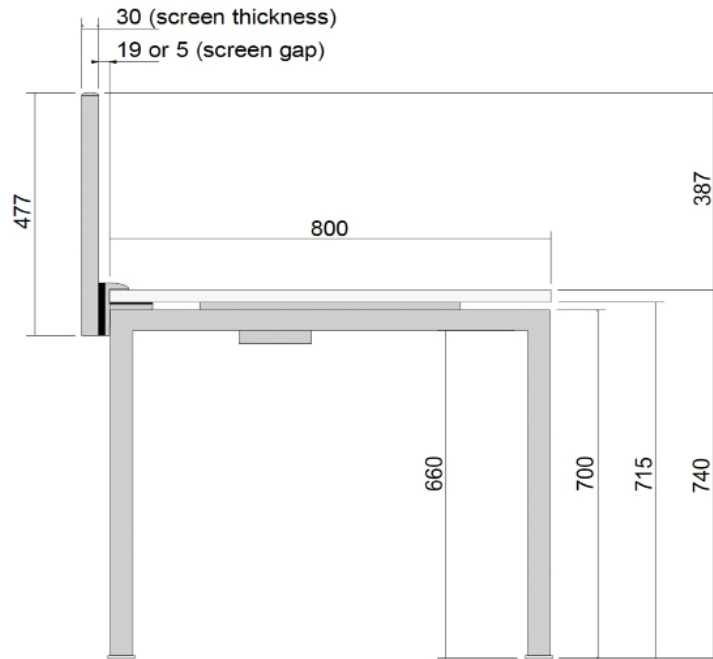

Cable Basket



580mm from the floor to the underside of the

The Desk Cable Basket Bracket can be used in two positions so that the wire basket is either 75mm from the back edge of the worksurface (shown on right), or flush with the back edge of the worksurface (shown on left), depending on the orientation of the bracket.

Cable Tray



567mm from the floor to the underside of the tray

547mm from the floor to the underside of the tray

The Cable Tray can be mounted in 2 positions in relation to the back edge, and can be fixed facing either direction. They can be fitted flush to the worksurface resulting in a 567mm distance to the floor.

Alternatively, a 20mm cable gap can also be facilitated, resulting in a 547mm distance to the floor.

Leg Range Dimension Guide

800 Desk Leg

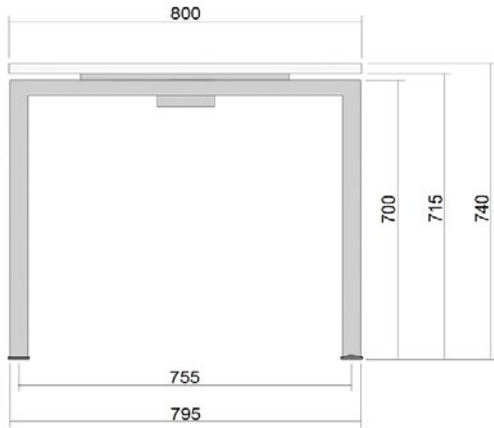

600 Desk Leg

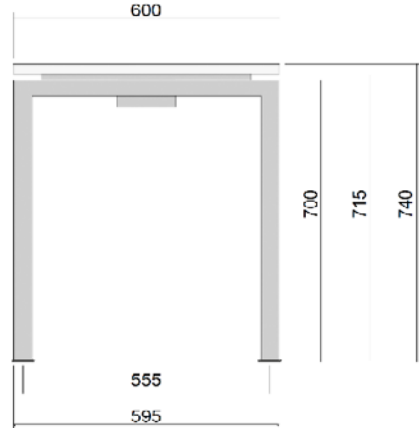

1600 Bench Leg

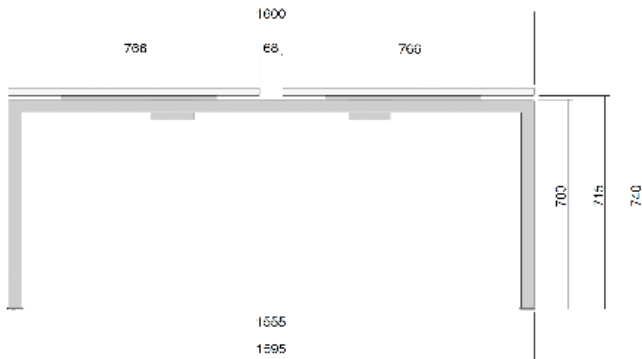

1200 Bench Leg

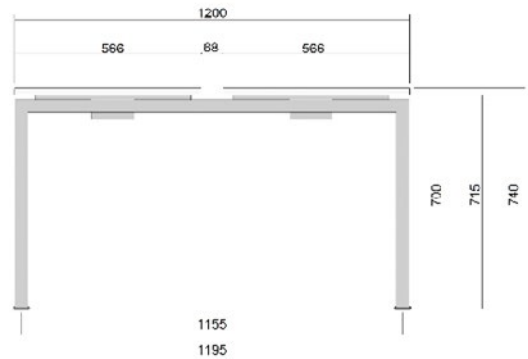

1600 Intermediate Bench Leg

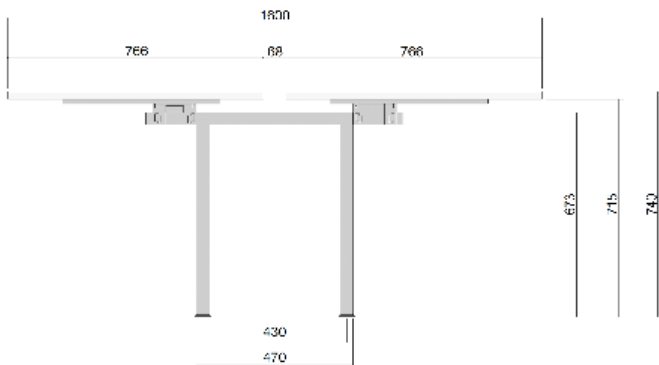

1200 Intermediate Bench Leg

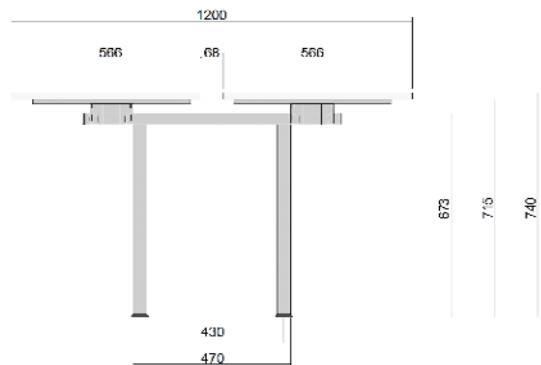

Notes

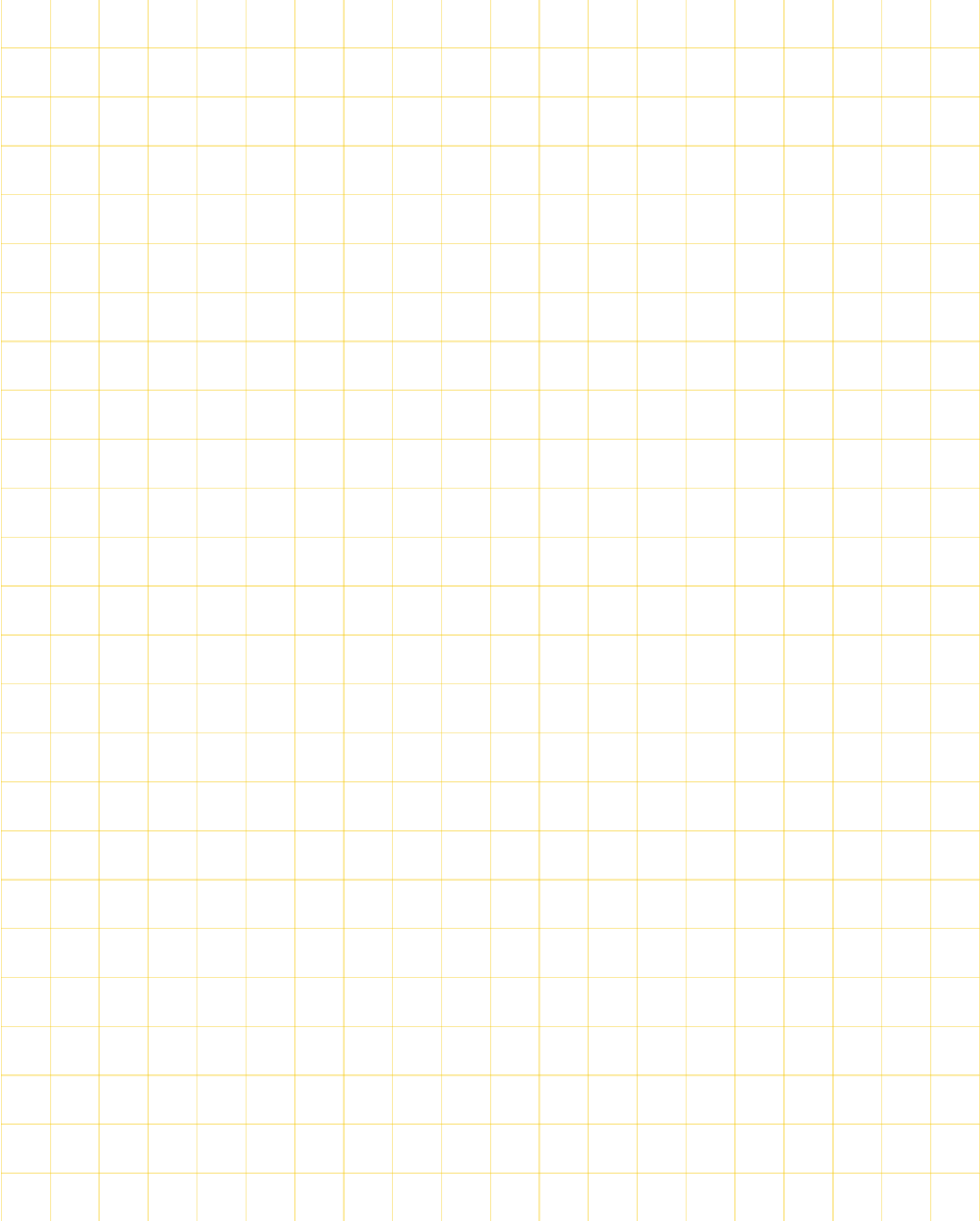

Showroom

Conveniently located in London, our newly refurbished Clerkenwell showroom exhibits Staverton's wide range of products. Come and visit us to see our offering for yourself.

[17-18 Hayward's Place](#)
[London, EC1R 0EQ](#)

Stay in Touch

To find out more or book an appointment, please contact us.

+44 (0)20 3794 1200
info@staverton.co.uk
staverton.co.uk



Staverton reserves the right to alter the prices and specifications without notice.



012



The mark of responsible forestry

